



TIEMME

COLLETTORI CON RUBINETTO MANIFOLDS WITH STOP COCKS

Serie MAXIMA

Collettori lineari componibili con derivazioni dotate di rubinetto di chiusura. Disponibile con mandata da 3/4" od 1" e 2, 3, 4, 5 o 6 attacchi con interasse 36mm o 50mm.

Modular linear manifolds with ways provided of stop cocks.

Available with delivery 3/4" or 1" and 2, 3, 4, 5 or 6 pipe connections with distance between axis of 36mm or 50mm..

I collettori di distribuzione "MAXIMA" sono generalmente utilizzati nelle reti di distribuzione di acqua calda e fredda.

Grazie alla loro configurazione permettono l'alimentazione in parallelo delle utenze per acqua calda e/o fredda riducendo al minimo le perdite di carico.

I collettori sono prodotti in conformità alle normative in materia e sono certificati relativamente alla composizione chimica dei materiali impiegati ed a livello dimensionale.

The distribution manifolds "MAXIMA" are typically used for hot and cold water distribution.

Due to the configuration they may be used to distribute cold/hot water in parallel reducing at minimum the pressure drop.

The manifolds are produced according to the relevant rules and are certified for material chemical composition and dimensional request.



Per la gamma completa vedere il catalogo / For complete range see catalogue

Certificazioni / Certifications

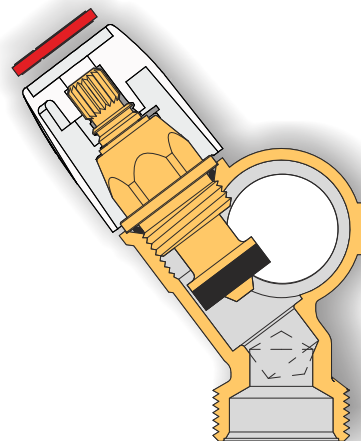

Caratteristiche Tecniche

Temperatura max di esercizio : 110°C
Temperatura min di esercizio : -20°C(*)
Pressione max di esercizio : 16 bar
Filettature : femmina ISO 228 (cilindrica)
maschio ISO 228 (cilindrica)

Technical Features

Maximum temperature : 110°C
Minimum temperature : -20°C(*)
Maximum operating pressure : 16 bar
Threads : female ISO 228 (parallel)
male ISO 228 (parallel)

Descrizione

Corpo
Vitone
O-rings
Guarnizione
Manopola
Dischetto segna utenza

Materiale

Ottone CW617N - EN12165
Ottone CW617N - EN12164
Gomma etilene-propilene EPDM
Gomma etilene-propilene EPDM
ABS bianca
ABS rosso/blu

Trattamento

Cromato

Description

Body
Head screw
O-rings
Washer
Handle
Diskette marks use

Material

CW617N-EN12165 brass
CW617N-EN12164 brass
Etilene-propylene rubber EPDM
Etilene-propylene rubber EPDM
ABS white
ABS red/blue

Treatment

Chrome plated

(*) purché il fluido rimanga in fase liquida / provided that the fluid remains in the liquid phase



TIEMME Raccorderie S.p.A.
Via Cavallera 6/A (Loc. Barco) - 25045 Castegnato (Bs) - Italy
Tel +39 030 2142211 R.A. - Fax +39 030 2142206
info@tiemme.com - www.tiemme.com





TIEMME

COLLETTORI CON RUBINETTO MANIFOLDS WITH STOP COCKS

Serie MAXIMA



Tabella dimensioni / Sizes table

Size M / F	Vie/ Ways	A	B	C	D	E	E 1	F	G	H	I	L	Ø	Ch	Codice/ Code
3/4"	2	3/4"	36	1/2"	16	13	15	27,5	24	87,5	39	44	28	32	1860008
	3	3/4"	36	1/2"	16	13	15	27,5	24	123,5	39	44	28	32	1860005
	4	3/4"	36	1/2"	16	13	15	27,5	24	159,5	39	44	28	32	1860004
	5	3/4"	36	1/2"	16	13	15	27,5	24	195,5	39	44	28	32	1860010
	6	3/4"	36	1/2"	16	13	15	27,5	24	231,5	39	44	28	32	1860083
1"	2	1"	36	1/2"	16	13	15,5	29	25,5	90,5	40	45	33	38	1860022
	3	1"	36	1/2"	16	13	15,5	29	25,5	126,5	40	45	33	38	1860021
	4	1"	36	1/2"	16	13	15,5	29	25,5	162,5	40	45	33	38	1860020
	5	1"	36	1/2"	16	13	15,5	29	25,5	198,5	40	45	33	38	1860028
	6	1"	36	1/2"	16	13	15,5	29	25,5	234,5	40	45	33	38	1860084
3/4"	2	3/4"	36	24x19 fil	18	13	15	27,5	24	87,5	37	44	28	32	1860023
	3	3/4"	36	24x19 fil	18	13	15	27,5	24	123,5	37	44	28	32	1860018
	4	3/4"	36	24x19 fil	18	13	15	27,5	24	159,5	37	44	28	32	1860014
	5	3/4"	36	24x19 fil	18	13	15	27,5	24	195,5	37	44	28	32	1860016
	6	3/4"	36	24x19 fil	18	13	15	27,5	24	231,5	37	44	28	32	1860085
1"	2	1"	36	24x19 fil	18	13	15,5	29	25,5	90,5	39	45	33	38	1860006
	3	1"	36	24x19 fil	18	13	15,5	29	25,5	126,5	39	45	33	38	1860003
	4	1"	36	24x19 fil	18	13	15,5	29	25,5	162,5	39	45	33	38	1860002
	5	1"	36	24x19 fil	18	13	15,5	29	25,5	198,5	39	45	33	38	1860001
	6	1"	36	24x19 fil	18	13	15,5	29	25,5	234,5	39	45	33	38	1860086
3/4"	2	3/4"	50	3/4"	18	13	15	32	31	113,0	38	44	28	32	1860026
	3	3/4"	50	3/4"	18	13	15	32	31	163,0	38	44	28	32	1860011
	4	3/4"	50	3/4"	18	13	15	32	31	213,0	38	44	28	32	1860015
1"	2	1"	50	3/4"	18	13	15,5	32	31	113,0	39,5	45	33	38	1860024
	3	1"	50	3/4"	18	13	15,5	32	31	163,0	39,5	45	33	38	1860013
	4	1"	50	3/4"	18	13	15,5	32	31	213,0	39,5	45	33	38	1860019
3/4"	2	3/4"	50	24x19 fil	18	13	15	32	31	113,0	37	44	28	32	1860043
	3	3/4"	50	24x19 fil	18	13	15	32	31	163,0	37	44	28	32	1860041
	4	3/4"	50	24x19 fil	18	13	15	32	31	213,0	37	44	28	32	1860044
1"	2	1"	50	24x19 fil	18	13	15,5	32	31	113,0	39	45	33	38	1860032
	3	1"	50	24x19 fil	18	13	15,5	32	31	163,0	39	45	33	38	1860031
	4	1"	50	24x19 fil	18	13	15,5	32	31	213,0	39	45	33	38	1860029

TIEMME Raccorderie S.p.A. si riserva di apportare modifiche in qualsiasi momento senza preavviso. TIEMME Raccorderie S.p.A. reserves the right to modify contents in any time without prior advise. È vietata qualsiasi forma di riproduzione, se non autorizzata. It is forbidden any reproduction unless under TIEMME authorization.

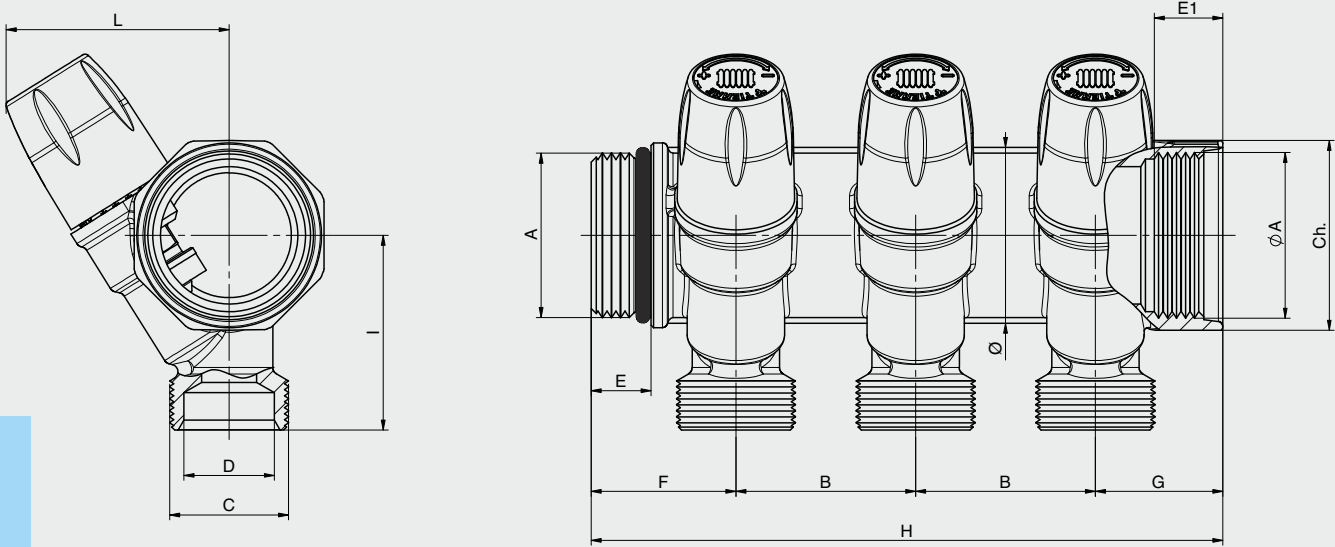

TIEMME Raccorderie S.p.A.
Via Cavallera 6/A (Loc. Barco) - 25045 Castegnato (Bs) - Italy
Tel +39 030 2142211 R.A. - Fax +39 030 2142206
info@tiemme.com - www.tiemme.com





TIEMME

COLLETTORI CON RUBINETTO MANIFOLDS WITH STOP COCKS

Serie MAXIMA

Diagramma portata/perdita di carico - Flow/pressure drop diagram

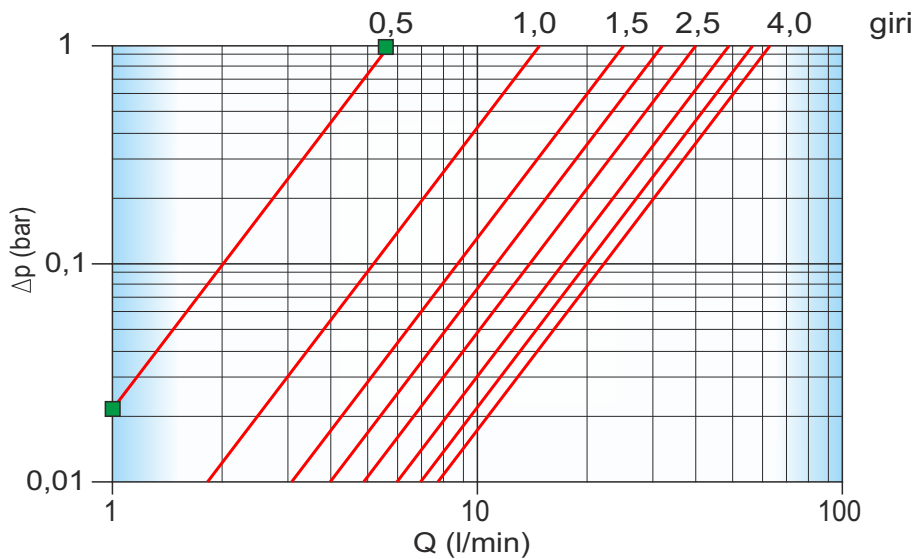

0,5 giri / turns	Kv	0,34
1,0 giri / turns	Kv	0,91
1,5 giri / turns	Kv	1,44
2,0 giri / turns	Kv	1,91
2,5 giri / turns	Kv	2,40
3,0 giri / turns	Kv	2,89
3,5 giri / turns	Kv	3,33
4,0 giri / turns	Kv	3,78

Collettore interasse 36mm con derivazioni 1/2"x16 (1866K-1868K)

Manifold with 1/2"x16 outlets and distance between axis of 36mm (1866K-1868K)

Guida alle connessioni

Fitting guide

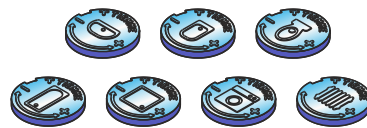

Dischetti segna utenza
Diskette marks use

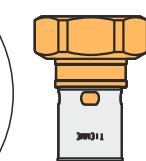
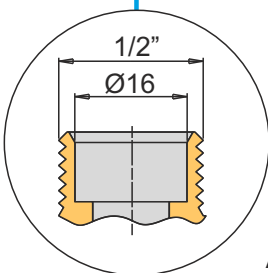
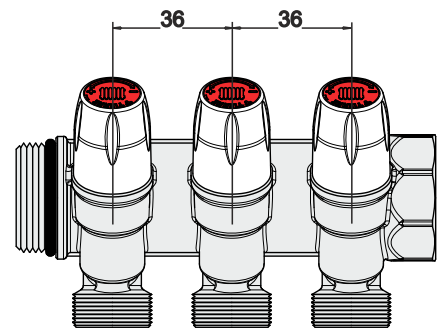
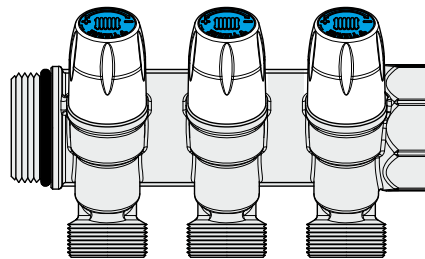
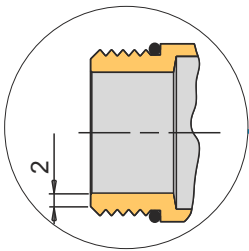

Art. 1716
Per tubo Pe-x
For Pe-x pipe

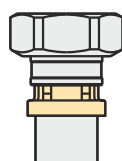

Art. 1668K
Per tubo multistrato
For multilayer pipe

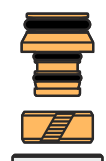

Art. 1635K
Per tubo multistrato
For multilayer pipe



Art. 1240K
Per tubo rame
For copper pipe

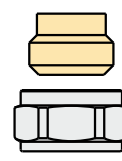

Art. 1233K
Art. 1235K
Per tubo rame
For copper pipe

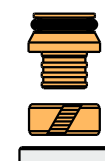

Art. 1435K
Per tubo Pe-x
For Pe-x pipe

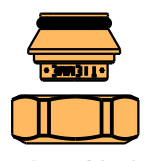

Art. 1879G0004
Tappo
Cap

TIEMME
ORIGINAL ITALIAN TRADEMARK

TIEMME Raccorderie S.p.A.
Via Cavallera 6/A (Loc. Barco) - 25045 Castegnato (Bs) - Italy
Tel +39 030 2142211 R.A. - Fax +39 030 2142206
info@tiemme.com - www.tiemme.com

kiwa
Partner for progress



TIEMME

COLLETTORI CON RUBINETTO MANIFOLDS WITH STOP COCKS

Serie MAXIMA

Collettore interasse 36mm con derivazioni 24x19fil-18 (1877K36)

Manifold with 24x19fil-18 outlets and distance between axis of 36mm (1877K36)

Guida alle connessioni / Fitting guide

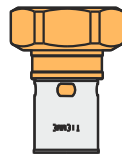
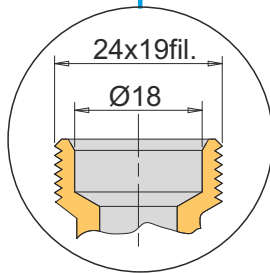
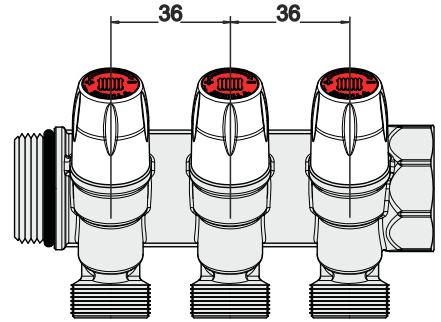
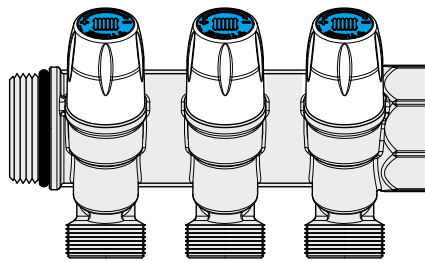
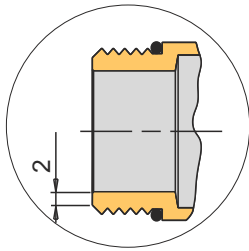

Art. 1716
Per tubo Pe-x
For Pe-x pipe

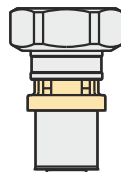

Art. 1666K24
Per tubo multistrato
For multilayer pipe



Art. 1633K
Per tubo multistrato
For multilayer pipe



Art. 1243K
Per tubo rame
For copper pipe



Art. 1433K
Per tubo Pe-x
For Pe-x pipe

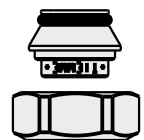

Art. 1879K2419
Tappo
Cap

Collettore interasse 50mm con derivazioni 3/4"x18 Eurocono (1877K5005)

Manifold with 3/4"x18 Euroconus outlets and distance between axis of 50mm (1877K5005)

Guida alle connessioni / Fitting guide

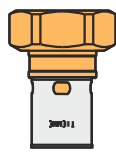
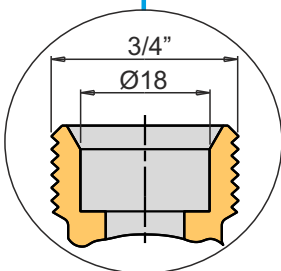
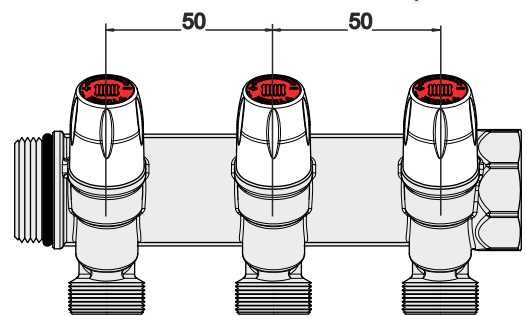
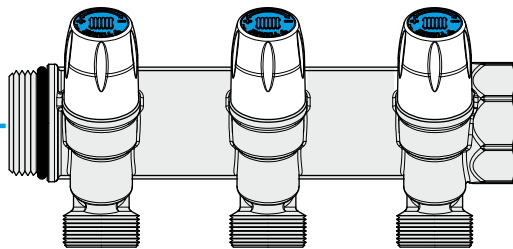
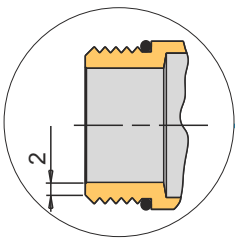

Art. 1716
Per tubo Pe-x
For Pe-x pipe

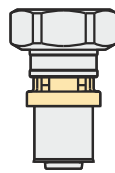

Art. 1666K
Per tubo multistrato
For multilayer pipe



Art. 1636K
Per tubo multistrato
For multilayer pipe



Art. 1241K
Per tubo rame
For copper pipe



Art. 1436K
Per tubo Pe-x
For Pe-x pipe

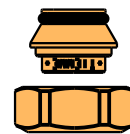

Art. 1879G0005
Tappo
Cap



Art. 1859G0005
Adattatore per sede
piana
Adapter for plain
end connection

TIEMME Raccorderie S.p.A. si riserva di apportare modifiche in qualsiasi momento senza preavviso.
 TIEMME Raccorderie S.p.A. reserves the right to modify contents in any time without prior advise.
 È vietata qualsiasi forma di riproduzione, se non autorizzata.
 It is forbidden any reproduction unless under TIEMME autorization



TIEMME Raccorderie S.p.A.
 Via Cavallera 6/A (Loc. Barco) - 25045 Castegnato (Bs) - Italy
 Tel +39 030 2142211 R.A. - Fax +39 030 2142206
 info@tiemme.com - www.tiemme.com





TIEMME

COLLETTORI CON RUBINETTO MANIFOLDS WITH STOP COCKS

Serie MAXIMA

Collettore interasse 50mm con derivazioni 24x19fil-18 (1877K5019)

Manifold with 24x19fil-18 outlets and distance between axis of 50mm (1877K5019)

Guida alle connessioni / Fitting guide

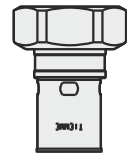
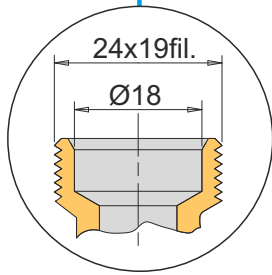
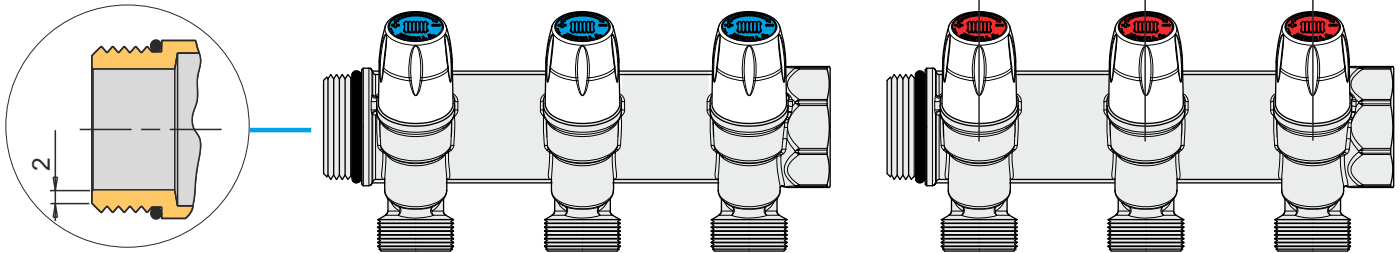

Art. 1715
Per tubo Pe-x
For Pe-x pipe

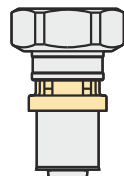

Art. 1666K24
Per tubo multistrato
For multilayer pipe



Art. 1633K
Per tubo multistrato
For multilayer pipe



Art. 1243K
Per tubo rame
For copper pipe



Art. 1433K
Per tubo Pe-x
For Pe-x pipe

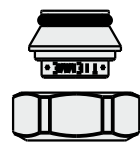

Art. 1879K2419
Tappo
Cap

Esempio di accoppiamento collettori con filettatura maschio/femmina fasata Example of connection for manifolds with male/female self-seal thread

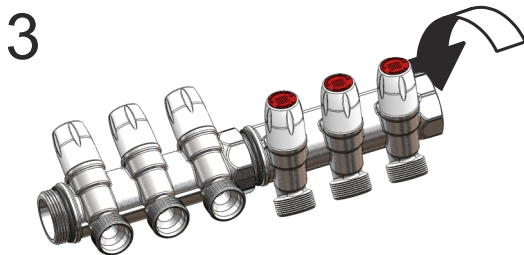
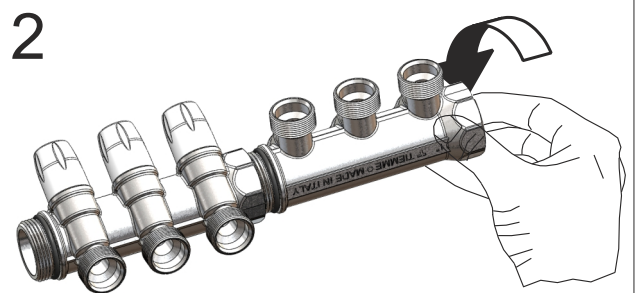
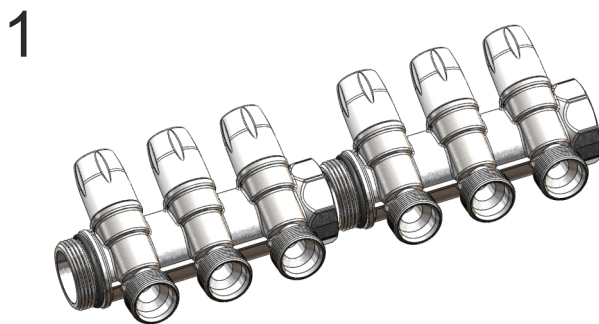

Avvitare i collettori fino in battuta.
Screw the manifolds until securely abutted

Qualora non fossero allineati, svitare all'occorrenza
Should the manifolds not be aligned, unscrew as required.

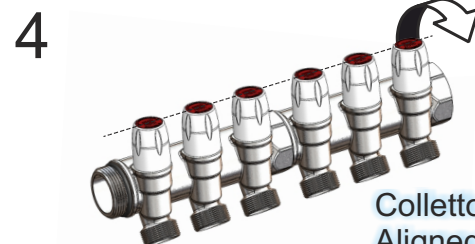

Collettori allineati
Aligned manifolds

TIEMME Raccorderie S.p.A. si riserva di apportare modifiche in qualsiasi momento senza preavviso.
TIEMME Raccorderie S.p.A. reserves the right to modify contents in any time without prior advise.
È vietata qualsiasi forma di riproduzione, se non autorizzata.
It is forbidden any reproduction unless under TIEMME authorization



TIEMME Raccorderie S.p.A.
Via Cavallera 6/A (Loc. Barco) - 25045 Castegnato (Bs) - Italy
Tel +39 030 2142211 R.A. - Fax +39 030 2142206
info@tiemme.com - www.tiemme.com





TIEMME

COLLETTORI CON RUBINETTO MANIFOLDS WITH STOP COCKS

Serie MAXIMA

Cassette utilizzabili
Boxes used

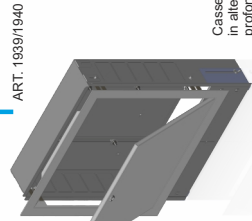
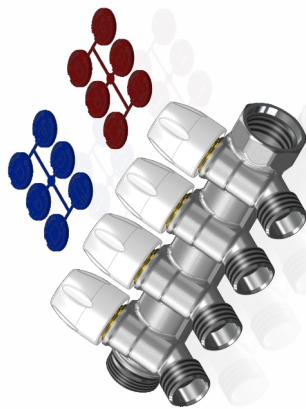
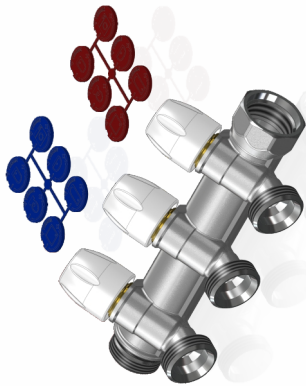

Cassetta regolabile in altezza e profondità
Metallic box with height and depth adjustable

ART. 1870



Supporto per collettori
Holding set for manifolds

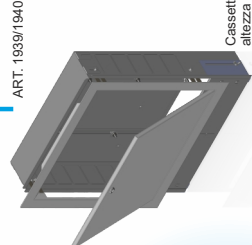

Cassetta regolabile in altezza e profondità
Metallic box with height and depth adjustable

ART. 1877SKIT



Kit di fissaggio per collettori
Manifolds bracket

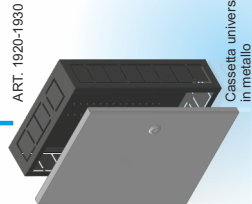

Cassetta universale in metallo
Universal metallic box

ART. 1807

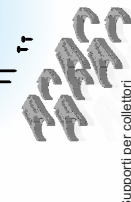

Supporti per collettori
Holding set for manifolds

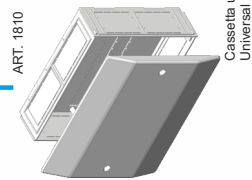

Cassetta universale
Universal box

ART. 1807

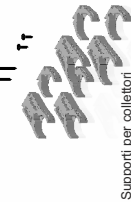

Supporti per collettori
Holding set for manifolds

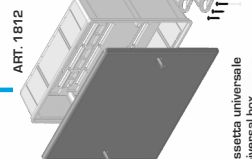

Cassetta universale
Universal box



TIEMME Raccorderie S.p.A. si riserva di apportare modifiche in qualsiasi momento senza preavviso.
TIEMME Raccorderie S.p.A. reserves the right to modify contents in any time without prior advise.
È vietata qualsiasi forma di riproduzione, se non autorizzata.
is forbidden any reproduction unless under TIEMME autorization



TIEMME Raccorderie S.p.A.
Via Cavallera 6/A (Loc. Barco) - 25045 Castegnato (Bs) - Italy
Tel +39 030 2142211 R.A. - Fax +39 030 2142206
info@tiemme.com - www.tiemme.com

