



RDD310

RDE410

## Semi flush-mounted room temperature controllers with LCD

**RDD310**  
**RDE410**

For heating systems

### RDD310 and RDE410 features:

- Operating voltage AC 230 V
- 2-position control with On / Off control output
- Input for an external temperature sensor (QAH11.1 / QAA32)
- Temperature limitation function for heating, controlled by external temperature sensor (optional)
- Operating modes: Comfort, Energy Saving and Frost Protection
- Manual changeover of current operating mode
- Maximum and minimum setpoint limitation
- Backlit LCD
- Mounting on recessed rectangular conduit box, fixing center at 60.3mm

### Additional RDE410 features:

- Auto Timer mode with 8 programmable timers (RDE410 only)

## Use

---

The RDD310 / RDE410 controls room temperature in heating systems.

Typical applications:

- Apartments
- Commercial spaces
- Schools

Controls the following equipment:

- Thermal valves or zone valves
- Gas or oil burners
- Fans
- Pumps

## Functions

---

- Maintain room temperature via built-in temperature sensor or external room temperature sensor. The controller automatically detects a connected external room temperature sensor. The built-in temperature sensor is disabled in this case.
- Select operating mode via the operating mode button on the controller.
- Display current room temperature or setpoint.
- Minimum and maximum setpoint limitation.
- Keypad lock (automatic or manual).
- Temperature limitation for floor heating with an external temperature sensor (optional).
- 7-day time switch: 8 programmable timers to change over between Comfort and Energy saving mode (RDE410 only).
- Backlit LCD

Function diagram

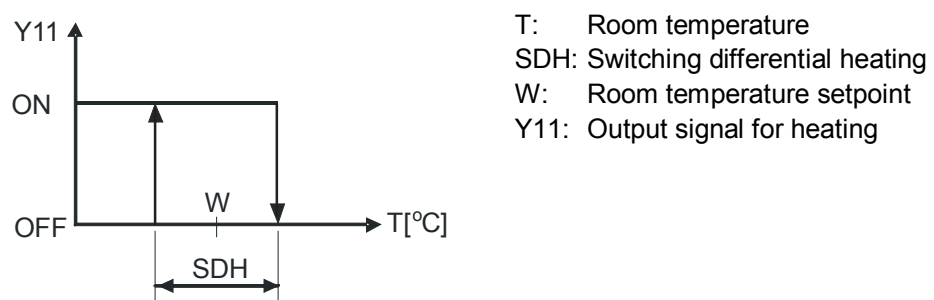

## Temperature control

---

The controller acquires the room temperature via built-in sensor, external room temperature sensor (QAA32), or external cable temperature sensor (QAH11.1). It maintains the setpoint by sending actuator control commands to the heating equipment. The switching differential is 1 K.

### External temperature sensor

The controller automatically detects when an external temperature sensor (QAH11.1 or QAA32) is connected.

## Floor heating limitation function

The floor heating limitation function is part of the floor heating application. The external floor temperature sensor connected to input B1 acquires the floor temperature. If the floor temperature exceeds the parameterized limit (parameter P51), the heating valve is fully closed until the floor temperature returns to 2 K below the parameterized limit. The factory setting for this function is OFF (disabled).

## Operating modes

Select the controller's operating mode via operating mode button . A corresponding setpoint is used to maintain the room temperature at the desired level depending on the active operating mode. The following operating modes are available:

### Comfort mode

In Comfort mode, the controller maintains the setpoint which can be adjusted via the +/- buttons.





### Energy Saving mode

Energy Saving mode helps save energy. Select it by pressing the operating mode button  if parameter P02 is set accordingly.

### Frost Protection mode

In Frost Protection mode, the system is protected against frost (factory setting 8 °C).

### Auto Timer mode (only with RDE410..)

In Auto Timer mode , the controller automatically changes from Comfort to Energy Saving mode as per the 8 preprogrammed timers. The display shows the Auto Timer mode symbol  along with the symbol for the current operating mode (Comfort  or Energy Saving ).

## User interface

### Display

The digital display displays the acquired room temperature or the setpoint for the current operating mode, selectable via parameter P06. Factory setting displays the current room temperature.

Use parameter P04 to select room temperatures and setpoints for display in °C or °F.

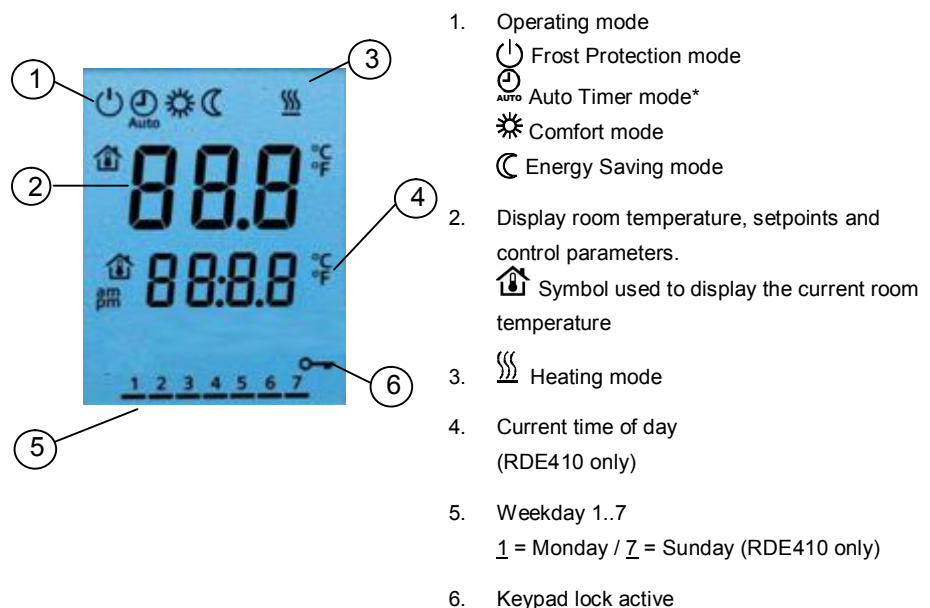







## Ordering

Indicate both product number and description when ordering:

E.g. **RDD310 room temperature controller**

Order sensors and valve actuators separately.

## Equipment combinations

	Description		Product no.	Data sheet <sup>*)</sup>
Sensors	Cable temperature sensor		<b>QAH11.1</b>	1840
	Room temperature sensor		<b>QAA32</b>	1747
On/off actuators	Electromotoric actuator with on/off valve (only available in AP, UAE, SA and IN)		<b>MVI... / MXI...</b>	4867
	Electromotoric on/off actuator		<b>SFA21...</b>	4863
	Thermal actuator (for radiator valves)		<b>STA21...</b>	4893
	Thermal actuator (for small valves 2.5 mm)		<b>STP21...</b>	4878
	Zone valve actuators (only available in AP, UAE, SA and IN)		<b>SUA...</b>	4830

<sup>\*)</sup> The documents can be downloaded from <http://siemens.com/bt/download>.

## Accessories

Description	Product no.	Data sheet
Changeover mounting kit (50 pcs/package)	<b>ARG86.3</b>	1840
Adapter plate 82 mm x 82 mm x 10 mm for conduit	<b>ARG70.3</b>	-
Conduit box 75mm x 75mm x 51mm	<b>ARG71</b>	-

## Mechanical design

The controller consists of two parts:

- Front panel accommodating the electronics, operating elements and built-in room temperature sensor.
- Mounting base with power electronics.

The rear of the mounting base contains the screw terminals. The base fits on a conduit box with 60.3 mm fixing centers. Slide the front panel in the mounting base and snap on.

RDD310



1. Operating mode selector / Frost Protection
2. Adjust setpoint and control parameters

RDE410

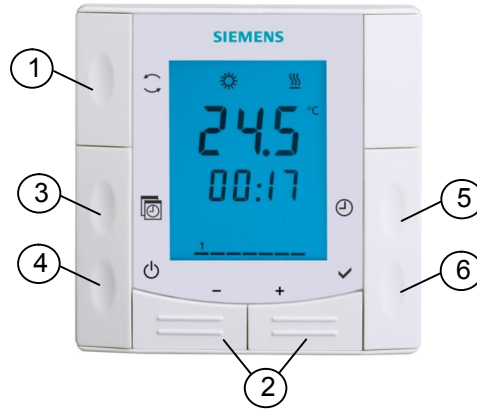

1. Operating mode selector
2. Adjust setpoints, control parameters and time of day
3. Auto Timer program
4. Frost Protection
5. Time of day and weekday
6. Confirm

## Setpoints

### Comfort mode ☀

The setpoint in Comfort mode is adjusted with the +/- buttons.

### Setpoint limitation

The setpoint setting range can be limited to minimum (parameter P09) and maximum (parameter P10) values (if the minimum setting is the same or higher than the maximum setting, the setting range is 5 °C...P10).

### Temporary setpoint

If "Temporary setpoint" is enabled via parameter P69, the setpoint adjusted via the +/- buttons is set back to the Comfort basic setpoint when the operating mode changes. Factory setting for the Comfort basic setpoint is 20 °C and can be changed via parameter P08.

### Energy Saving mode ☾

Use control parameters P11 to adjust the Energy Saving mode setpoint. Factory setting is 16 °C.

### Frost Protection mode ☁

Use control parameters P65 to adjust the Frost Protection mode setpoint. Factory setting is 8 °C.

### Caution ⚠

If a setpoint is set to OFF, the controller does not maintain the setpoint in the corresponding mode, resulting in a risk of frost, i.e. no protective heating or cooling function.

## Mounting notes

Mount the room controller on a recessed rectangular conduit box with 60.3 mm fixing centers. Do not mount on a wall in niches or bookshelves, behind curtains, above or near heat sources, or exposed to direct solar radiation. Mount about 1.5 m above the floor.

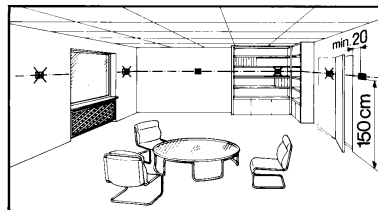

### Wiring

See the mounting instructions enclosed with the controller.



- Comply with local regulations to wire, fuse and earth the controller
- Properly size the cables to the controller and actuators for AC 230 V mains voltage.



- Use only actuators rated for AC 230 V on RDD310... / RDE410...
- The AC 230 V mains supply line must have an external fuse or circuit breaker with a rated current of no more than 10 A.



- Isolate the cables of SELV inputs B1-M.

## Installation notes

---



- |                               |  |
|-------------------------------|--|
| Sensor calibration            | <ul style="list-style-type: none"><li>Recalibrate the temperature sensor if the room temperature displayed on the controller does not match the room temperature measured. To do this, change parameter P05.</li></ul>   |
| Setpoint and range limitation | <ul style="list-style-type: none"><li>We recommend reviewing setpoints and setpoint ranges (parameters P08...P11) and change as needed to achieve maximum comfort and save energy.</li></ul>   |
| Reset parameters              | <ul style="list-style-type: none"><li>The factory setting for the control parameters can be reloaded via parameter P71, by changing the value to ON, and confirming by pressing buttons + and – simultaneously. The display shows “888” during reload.</li></ul>   |
| Floor temperature limitation  | <ul style="list-style-type: none"><li>The floor temperature sensor, connected to inputs B1-M, acquires the floor temperature. If the temperature exceeds the parameterized limit (parameter P51), the heating valve is fully closed until the floor temperature again drops to 2 K below the parameterized limit. The factory setting for this function is OFF (disabled).</li></ul> |

## Commissioning notes

---

After connecting to power, the controller carries out a reset during which all LCD segments flash indicating that the reset was correct. After the reset, which takes about 3 seconds, the controller is ready for commissioning by qualified HVAC staff. The control parameters of the controller can be set to ensure optimum performance of the entire system (see below).

### Control parameters for RDD310 and RDE410:

#	Parameter	Factory setting	Setting range
<b>Service level</b>			
P02	Mode selection by operating mode button 	1 = Frost Protection – Comfort mode	1 = Frost Protection – Comfort mode 2 = Frost Protection – Comfort – Energy Saving mode
P04	Selection of °C or °F	°C	°C or °F
P05	Temperature sensor calibration	0.0 °C	-3 ... 3 °C
P06	Standard temperature display	0 = room temperature	0 = room temperature 1 = setpoint
P08	Comfort basic setpoint	20 °C	5 ... 40 °C
P09	Min. setpoint limitation in Comfort mode ( $W_{min_{Comf}}$ )	5 °C	5 ... 40 °C
P10	Max. setpoint limitation in Comfort mode ( $W_{max_{Comf}}$ )	35 °C	5 ... 40 °C
P11	Heating setpoint in Energy Saving mode	16 °C	OFF, 5...18 °C
P14	Button lock (press operating mode button  for 7 seconds to lock or unlock the buttons)	0 = disabled	0 = disabled 1 = auto lock 2 = manual lock
<b>Expert level</b>			
P30	Switching differential in heating mode	1 K	0.5 ... 6 K
P51	Floor heating temperature limit	40 °C	OFF, 10...55 °C
P65	Setpoint of heating in Frost Protection mode  ( $W_{heat_{Stb}}$ )	8 °C	OFF, 5 °C...18 °C
P69	Temporary setpoint in Comfort mode	ON	OFF = Disabled ON = Enabled
P71	Parameter reset Set value to ON and confirm by pressing + and – buttons	---	OFF = Idle ON = Reset
<b>Diagnostics and test</b>			
d02	Status X1	Diagnostics	0...49 °C = measured temp. value

#### Parameter adjustment for service and expert level:

The parameters are divided into “Service level” and “Expert level”. The parameter setting mode can be entered as follows:

Set the controller to OFF / Frost Protection .

Service level only  
(P02...P14)

- Press buttons + and – simultaneously for 3 seconds. Release them and, within 2 seconds, press button + for another 7 seconds. Parameters P02...P14 can be adjusted (service level).

Expert level plus  
service level (all  
parameters,  
P02...P71)

- Press buttons + and – simultaneously for 3 seconds. Release them and, within 2 seconds, press button – for another 3 seconds. Parameters P02...P71 can be adjusted (expert level).

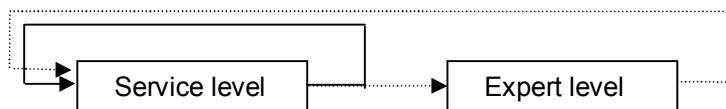

Parameters can be readjusted as follows in the parameter setting mode:

1. Select the required parameter by repeatedly pressing button + or –.
2. When pressing buttons + and – simultaneously, the current value of the selected parameter starts to flash; change by repeatedly pressing button + or –.
3. When you again press buttons + and – simultaneously, the next parameter is displayed.
4. Repeat steps 1 to 3 to display and change additional parameters.
5. (For RDD310) 10 seconds after the last display or setting, all changes are stored and the controller will leave parameter enter mode..  
(For RDE410) Press + or – until “End” is displayed, and then press + and – simultaneously to save the change and exit parameter entry mode.

## Maintenance notes

The controllers are maintenance-free.

## Disposal notes



The devices are considered electronics devices for disposal in term of European Directive 2012/19/EU and may not be disposed of as domestic waste.

- Dispose of the device via the channels provided for this purpose
- Comply with all local and currently applicable laws and regulations.

## Technical data

⚠ Power supply	Operating voltage	AC 230 V + 10/-15%	
	Frequency	50/60 Hz	
	Power consumption	Max. 8 VA	
Outputs	Control output Y11-N1 (N.O.)	AC 230 V	
	Rating	Max. 5(2) A	
Inputs	Temperature sensor input (B1-M):		
	Type	QAH11.1 (NTC) / QAA32	
Operational data	Switching differential, adjustable		
	Heating mode	(P30)	1K (0.5...6 K)
	Setpoint setting and range		
	☀ Comfort mode	(P08)	20 °C (5...40 °C)
	☾ Energy Saving mode	(P11)	16 °C (OFF, 5...40 °C)
	☹ Frost Protection	(P65)	8 °C (OFF, 5...40 °C)
	Floor temperature limitation setting range	OFF and 20...45 °C	
	Factory setting	OFF (limitation function not active)	
	Built-in room temperature sensor		
	Measuring range	0...49 °C	
Accuracy at 25 °C	< ± 0.5 K		
Temperature calibration range	± 3.0 K		
Settings and display resolution	Setpoints	0.5 °C	
	Current temperature value displayed	0.5 °C	
	Operational data		
Environmental conditions	Operation	As per IEC 60721-3-3	
	Climatic conditions	Class 3K5	
	Temperature	0...+50 °C	
	Humidity	< 95% r.h.	



Standards	Transport	As per IEC 60721-3-2
	Climatic conditions	Class 2K3
	Temperature	-25...+60 °C
	Humidity	<95% r.h.
	Mechanical conditions	Class 2M2
	Storage	As per IEC 60721-3-1
	Climatic conditions	Class 1K3
	Temperature	-25...+60 °C
	Humidity	<95% r.h.
	EU Conformity (CE)	CE1T3076_1 <sup>*)</sup> CE1T3076xx_2 <sup>*)</sup>
RCM Conformity	CE1T3076_1en_C1 <sup>*)</sup> CE1T3076xx_2en_C1 <sup>*)</sup>	
	Protective class	II as per EN 60730-1
Pollution class	Normal	
Environmental compatibility	Degree of protection of housing	IP30 as per EN 60529
	The product environmental declarations CE1E3076_1, CE1E3076_2 <sup>*)</sup> contain data on environmentally compatible product design and assessments (RoHS compliance, materials composition, packaging, environmental benefit, disposal).	
General	Connection terminals	Solid wires or prepared stranded wires 2x0.4-1.5 mm <sup>2</sup> or 1x2.5 mm <sup>2</sup>
	Weight	0.220 kg
	Housing front color	RAL 9003 white
	*) The documents can be downloaded from <a href="http://siemens.com/bt/download">http://siemens.com/bt/download</a> .	

## Connection terminals

Terminal connections for RDD310... / RDE410... are shown in the table below.

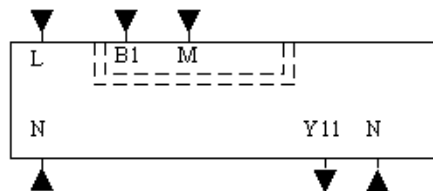

L, N	Operating voltage AC 230 V
Y11	Control output "Valve" AC 230 V (N.O., for normally closed valves) or output for electric heater
B1	Input for external temperature sensor (room temperature sensor, floor temperature sensor, etc.)
M	Measuring neutral for sensor

## Connection diagrams

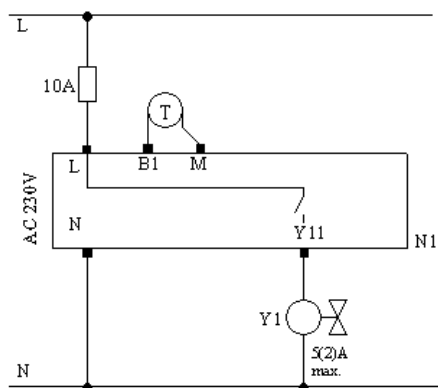

N1	Room temperature controller RDD310... / RDE410...
Y1	Zone valve
B1	Temperature sensor

## Application examples

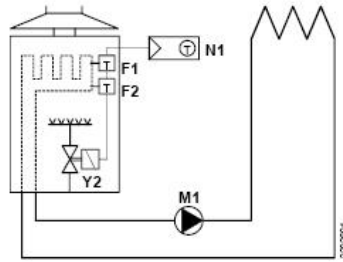

Room temperature controller with direct control of a gas-fired wall-hung boiler

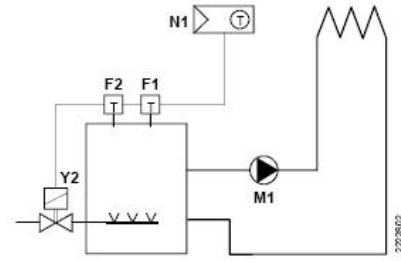

Room temperature controller with direct control of a gas-fired floor-standing boiler

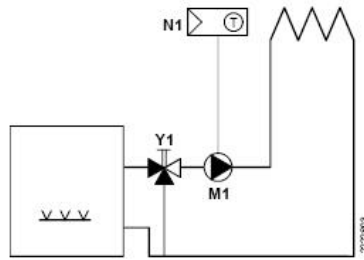

Room temperature controller with direct control of a heating circuit pump (precontrol by manual mixing valve)

F1	Thermal reset limit thermostat	N1	RDD310/RDE410 room temperature controller
F2	Safety limit thermostat	Y1	3-port valve with manual adjustment
M1	Circulating pump	Y2	Magnetic valve

# Dimensions

