

pločasti materijali



šuplji blok



KD



KD H

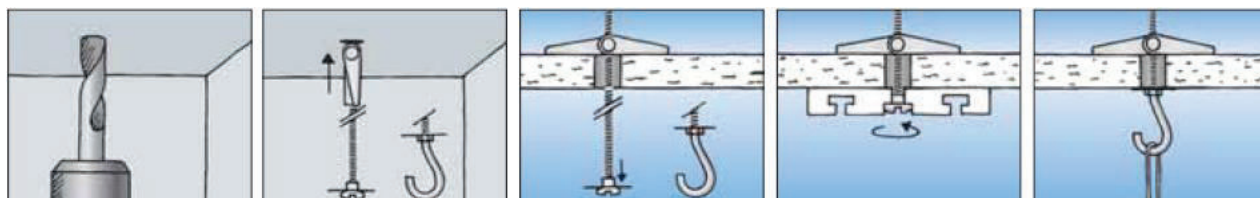
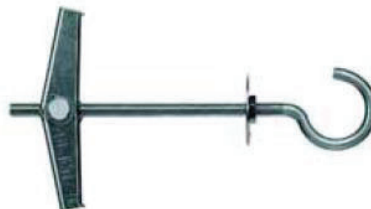

Naziv	Ø burgije	Max. debljina panela	Dužina vijka	Navoj	Pakovanje	
	mm	mm	mm	mm	šifra	kom
KD 3	12	65	95	M3 x 90	80181	50
KDH 3	12	51	105	M3 x 80	80182	25
KD 3 B	12	65	95	M3 x 90	80192	10
KD 4	14	69	105	M4 x 100	80183	25
KDH 4	14	35	95	M4 x 70	80184	25
KD 4 B	14	69	105	M4 x 100	80193	10

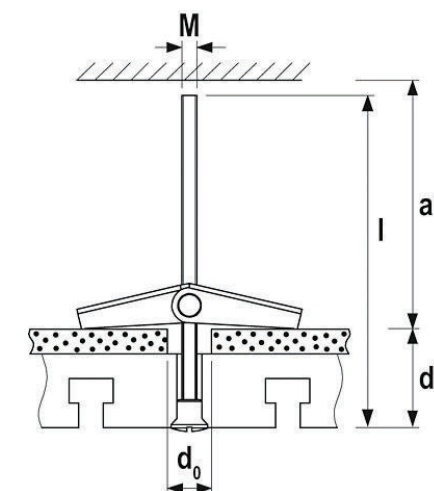

pločasti materijali



šuplji blok



KD H

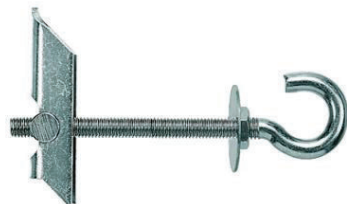

KD

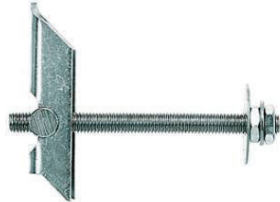

KM

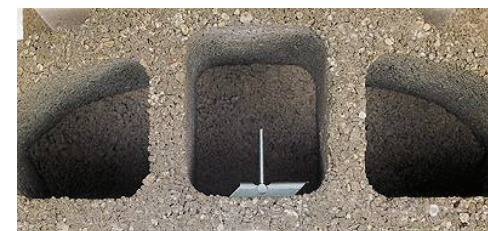
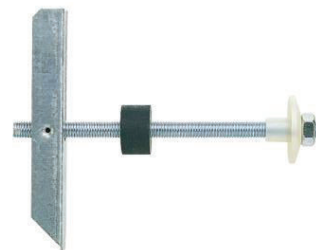

Naziv	Ø burgije	Max. debljina panela	Dužina vijka	Navoj	Pakovanje	
	mm	mm	mm	mm	šifra	kom
KD 5	16	63	100	M5 x 100	80187	25
KDH	16	60	130	M5 x 90	80188	20
KD 6	16	63	100	M6 x 100	80185	25
KDH 6	16	60	130	M6 x 100	80186	20
KD 8	20	55	100	M8 x 100	80178	20
KDH 8	20	55	130	M8 x 100	80179	20
KM 10	30	90	240	M10 x 180	50326	25

