

Synco™ 700



Universal controller

RMU7..B

- With yearly timeswitch
- Each type of controller is supplied with 5 different ventilation/air conditioning plants preprogrammed
- Freely programmable controller, for optimum adaptation to the relevant type of plant
- Modular expandable with extension modules RMZ785, RMZ787 and RMZ788
- Menu-driven operation with separate operator unit (plug-in type or detached)
- KNX bus connection for operation and process information.

Application

For use on basic to complex ventilation, air conditioning and cold water plants and primary air handling featuring communicative room thermostats.

The universal controllers are designed to handle the following controlled variables: Temperature, relative/absolute humidity, pressure/differential pressure, airflow, indoor air quality and enthalpy.

Functions

Timeswitch and operating modes

- Yearly timeswitch with automatic summer-/wintertime changeover.
- 7-day program (6 switching points per day) and yearly program for holidays/special days (16 periods).
- Selection of operating mode
with local operator unit: auto, comfort, precomfort, economy and protection or via status inputs: Comfort, precomfort, economy and protection.
- Room controller combination with multiple ventilation controllers or heating controllers via the KNX bus. Exchange information such as room temperature, operating mode and setpoints.
- Display of the current operating mode (comfort, precomfort, economy and protection), including the reason for it

Setpoints	<ul style="list-style-type: none"> • Depending on the sequence controller: Individually adjustable heating and cooling setpoints (or maximum and minimum setpoints) for comfort and precomfort modes • Predefined room temperature setpoint with room unit or relative setpoint adjuster (passive) • Depending on the sequence controller: Predefined setpoint with absolute remote setpoint adjuster (active or passive) • Room temperature setpoint with summer and/or winter compensation • Depending on the sequence controller: Setpoint shift depending on a sensor, selectable start and end points
Universal inputs	<p>8 universal inputs for</p> <ul style="list-style-type: none"> • Passive or active analog input signals of the following measured values (°C, %, g/kg, kJ/kg, W/m², bar, mbar, m/s, Pa, and ppm, Universal 000.0, Universal 0000, pulse). • Digital input signals (potential-free contacts)
Additional I/Os through extension modules	<p>Additional inputs and outputs to extend functionality. Total max. 4 extension modules per RMU7..B can be connected. Select from:</p> <ul style="list-style-type: none"> • max. 1 universal module RMZ785 (8 universal inputs). • max. 2 universal modules RMZ787 (4 universal inputs, 4 relay outputs). • max. 2 universal modules RMZ788 (4 universal inputs, 2 analog outputs, 2 relay outputs).
Data acquisition	<p>Pulse meter (for display only, not for billing purposes). Two meters available to acquire consumption data. Processes pulses from gas, hot water, low-temperature hot water, chilled water, electricity meters.</p> <ul style="list-style-type: none"> • Pulse metering (Wh, kWh, MWh, kJ, MJ, GJ, ml, l, m³, heating costs units, BTU, no unit). <p>Trend data display Four independent trend channels available to log measured values for a set period. KNX bus room temperature and outside air temperatures can be logged in addition to logical device inputs.</p>
Control functions	<ul style="list-style-type: none"> • Sequence controller for 3 heating sequences (reverse acting) and 2 cooling sequences (direct acting), can be used as a controller providing P, PI or PID mode, or as a differential controller • Controller can be configured as a room/supply air temperature cascade controller with limitation of the supply air temperature • Each sequence can be assigned modulating control (modulating output, step switch, mixed air damper, heat recovery equipment) and a pump. Up to 3 sequences can act on the same analog control (e.g. priority cooling/dehumidification) • General limitation function (minimum / maximum with PI mode per sequence controller, either as absolute limitation (e.g. for the supply air temperature or supply air humidity), or as relative temperature limitation (e.g. maximum limitation of the room/supply air temperature differential). Limitation acts on all sequences. Minimum limitation for switched on cooling (example: cooling with direct expansion cooler battery) can be set to a lower setpoint. • Sequence limitation function with PI mode per sequence controller, can be defined as minimum or maximum limitation. Limitation acts on a single sequence (e.g. heat recovery anti-icing protection or maximum limitation of the air heating coil's return temperature) • Lock individual sequences by outside air temperature. • Messages about deviations of setpoint/actual value per sequence controller

Fans

Control and monitor supply air and extract air fan with preselected command, preselected command feedback signal and operating hours meter.

- Single-speed fan (recirculated air operation possible)
- 2-speed fan (lock the second speed per outside air temperature)
- Speed-controlled fan, including pressure or volume flow controller.

Pumps

Control and supervise up to 4 simple or twin pumps.

- Pump kick.
- Permanent ON for low outside air temperatures.
- ON after last sequence controller or per operating mode.
- Plant stop for pump fault depending on the outside temperature.

Heat recovery

Control heat recovery.

- Maximum economy changeover.
- Efficiency monitoring.
- Enabling relay for heat recovery.

Mixed air damper

Control mixed air damper.

- Maximum economy changeover.
- Minimum position.
- Startup and maximum position depending on the outside air temperature.
- Mixed air damper temperature control at a constant setpoint (economizer).

Linear/binary step switch

Control of up to 3 available function blocks, each with 1 **linear** or **binary** step switch with a maximum of 4 relay outputs and 1 analog output.

Variable step switch

Control of 2 available function blocks with a **variable** step switch with 6 or 4 steps and one analog output each.

Logic functions

Four freely configurable logic function blocks are available to process multiple logically linked universal input variables.

- Configurable logic functions.
- Adjustable switch-on and switch-off delay and minimum switch-on and switch-off time.
- Operating switch (auto, off, on), configurable for manual control.

Additional timeswitch

Additional timeswitch with 6 daily switch-on or switch-off times.

- Operating switch (auto, off, on), configurable for manual control.

Demand-dependent ventilation (CO₂/VOC)

Demand-dependent ventilation (CO₂/VOC), acting on the air dampers or the variable speed/multispeed fans.

Frost protection

2-stage frost protection function (modulating/2-position) or frost protection thermostat (heating sequences delivering 100 % output, fans switched off).

- Frost protection and 3 frost protection monitors.

Preheating function

The following preheating functions are available:

Switch-on optimization

Comfort function Switch-on optimization for heating and cooling.

Sustained mode

- Sustained heating and cooling mode during occupied or unoccupied periods.

Night cooling

Night purging during unoccupied periods in the summer.

Heating/cooling demand

- Output of heat and cooling demand signal (relay and DC 0...10 V).
- Collect, evaluate and forward heat and cooling demand from and via the KNX bus.

Can also be configured:

- Modeling output (e.g. for demand-dependent setpoint shift of a refrigeration machine).
- Relay output (e.g. to switch-on/switch-off a refrigeration machine).
- Demand-dependent setpoint shift acting on a primary controller.
- Adjustable setpoint increase for use with primary controller.

Switching heating/cooling

If a 2-pipe system (heating/cooling) is used, you can switch heating/cooling via a digital or analog input, via an operating mode switch (auto, heating, cooling), by date or via the KNX bus. The heating/cooling signal can be sent to the KNX bus or issued via a relay.

Fault messages

Fault indication with red LED, acknowledgement with button.

The following options are available:

- 2 relay outputs as fault message relay.
- 10 universal inputs as fault message inputs.
- 4 predefined fault inputs (filter supervision, fire shutdown, "supply air smoke extraction" and "extract air smoke extraction").

Bus functions

- Remote operation of KNX functions with RMZ792 bus operating unit.
- Room operator unit with the relevant functions.
- Indication of fault status messages delivered by other devices on the bus.
- Delivery of a common fault status message from all devices on the bus to a fault relay.
- Time synchronization.
- Passing on and adoption of outside temperature signal.
- Common control strategy of a ventilation controller with a heating controller or multiple ventilation controllers to control of the same room.
- Sending or receiving the yearly timeswitch schedule (holidays/special days) from some other controller.
- Sending or receiving the 7-day program or the yearly program for the holidays/special days of any other controller.
- Generating and sending a demand signal (hot water, chilled water) to the primary controller or the hot water/chilled water source.
- Receiving and evaluating refrigeration demand signals if configured as a primary controller or hot water/chilled water source.

Demand control: Exchange of data between primary and VAV individual room control using the following functions via KNX bus:

- Demand-dependent plant operation primary ventilation plant (switch on and off based on load) and demand-dependent supply air temperature control
- Receive and evaluate energy demand signals (heating and cooling)
- Pressure setpoint compensation supply/extract air fan functioning as VAV damper position

Universal sending and receiving zones

Device RMU7x0B allows for universal data exchange via own terminals as well as via terminals of extension modules RMZ78x.

Data between devices is exchanged via KNX bus.

Universal inputs, digital and analog outputs of RMU7x0B can be used as sending objects (for sending zones).

Universal inputs of RMU7x0B can be used as receiving objects (in receiving zones).

- Sending zones:
 - Universal inputs (N.X1...A8(2).X4)
 - Digital outputs (N.Q1...A8(2).Q5)
 - Analog outputs (N.Y1...A8(2).Y2)
- Receiving zones:
 - Universal inputs (N.X1...A8(2).X4)

Examples of applications not permitted using KNX bus

The following applications or input/output values may **not** be implemented using universal sending and receiving zones:

- Safety-relevant plants and equipment (e.g. fire alarm off, smoke extraction, frost protection function).
- If request "Simultaneous synchronous start condition of plants" exists.
- Applications where communications failure of sending *or* receiving zones may cause damage.
- Time-critical control paths *or* control paths with greater degree of difficulty (e.g. speed control via pressure, humidity).
- Main controlled variables that must be available.
- Acquisition and evaluation of pulses.

Note

After RMU7x0B power-up, it may take a few minutes until the bus signals are available. This may result in faulty plant behavior in the case of sending and receiving zone applications that are not allowed.

Service and operating functions

- Display of setpoint and actual values.
- Input terminal simulation.
- Outside temperature simulation.
- Wiring test.
- Data backup.

Type overview

Controller	Type	Universal inputs	Positioning outputs	Switching outputs	Open control loop	Default languages
	RMU710B-1	6	2	2	1	de, fr, it, es, pt
	RMU720B-1	8	3	4	2	de, fr, it, es, pt
	RMU730B-1	8	4	6	3	de, fr, it, es, pt
	RMU710B-2	6	2	2	1	de, en, fr, nl
	RMU720B-2	8	3	4	2	de, en, fr, nl
	RMU730B-2	8	4	6	3	de, en, fr, nl
	RMU710B-3	6	2	2	1	sv, fi, no, da
	RMU720B-3	8	3	4	2	sv, fi, no, da
	RMU730B-3	8	4	6	3	sv, fi, no, da
	RMU710B-4	6	2	2	1	pl, cs, sk, hu, ru, bg
	RMU720B-4	8	3	4	2	pl, cs, sk, hu, ru, bg
	RMU730B-4	8	4	6	3	pl, cs, sk, hu, ru, bg
	RMU710B-5	6	2	2	1	ro, sl, sr, hr, el, tr
	RMU720B-5	8	3	4	2	ro, sl, sr, hr, el, tr
	RMU730B-5	8	4	6	3	ro, sl, sr, hr, el, tr
	RMU710B-6	6	2	2	1	zh
	RMU720B-6	8	3	4	2	zh
	RMU730B-6	8	4	6	3	zh

Accessories

Operator / service units

Name	Typ	Datenblatt
Operator unit, plug-in type	RMZ790	N3111
Operator unit, detached	RMZ791	N3112
Service tool	OC1700.1	N5655
Extension modules		
Universal module with 8 universal inputs	RMZ785	N3146
Universal module with 4 universal inputs and 4 relay outputs	RMZ787	N3146
Universal module with 4 universal inputs, 2 relay outputs and 2 analog DC 0...10 V outputs.	RMZ788	N3146
Module connector for detached extension modules	RMZ780	N3138

Ordering and delivery

When ordering, please provide the name and type reference of the controller, for example,

Universal controller **RMU730B-1**.

The devices and components listed under listed under "Accessories" must be ordered as separate items.

Each controller is supplied as follows:

- Complete with 5 standard applications plus one empty application each of basic types A, P, C and U (configuration must be adapted)
- Operating languages (see "Type overview")

Equipment combinations

The following table lists equipment that can be combined with the RMU7x0B and extension modules:

<i>Unit</i>	<i>Type</i>	<i>Data sheet</i>
Passive sensors	All sensors with sensing element LG-Ni1000, Pt1000, T1 (PTC)	N1721...N1846 N1713
Active sensors	All sensors with - AC 24 V supply voltage - modulating output DC 0...10 V	N1821, N1850...N1932
Monitoring devices	QAF81..., QAF64..., QFA1000, QFA1001, QFM81..., QXA2000, QBM81...	N1284, N1283, N1518, N1514, N1542, N1552
Passive signal sources	BSG21.1	N1991
Active signal sources	BSG61	N1992
Room units	QAA25, QAA27	N1721
Actuating equipment	All motorized, hydraulic and magnetic actuators with - operating voltage AC 24 V - for modulating control DC 0...10 V.	N4000...N4999
VAV Volume flow controller	G..B181.1E/3 G..B181.1E/KN networked versions	N3544 N3547
Variable speed drive	SED2...	N5192
Transformers	SEM62.1, SEM62.2	N5536

Product documentation

<i>Type of document</i>	<i>Ordering number</i>
Product range description: Synco™ 700	CE1S3110en
Basic Documentation: Universal Controllers RMU710B, RMU720B, RMU730B	CE1P3150en
Installation Instructions (G3151xx): RMB795, RMS705B, RMU7..B	74 319 0731 0
Operating Instructions Ge, En, Fr, NL (B3144x1). Universal controller RMU7..B.	74 319 0349 0
Data sheet: KNX bus	CE1N3127en
Basis documentation: Communication via KNX bus	CE1P3127en
CE Declaration of conformity: HVAC Controls Synco™ 700 Range	CE1T3110xx
Environmental product declaration	CE1E3110en01

Each type of controller has 5 applications of ventilation/air conditioning plants preprogrammed. Some of them require extension modules.

When commissioning a plant, the relevant plant type must be entered. All associated functions, terminal assignments, settings and displays will then automatically be activated, and parameters not required will be deactivated.

In addition, each type of universal controller has 4 empty applications loaded:

- 1 for basic type A (ventilation controller).
- 1 for basic type P (primary air handling).
- 1 for basic type C (demand-dependent chilled water controller).
- 1 for basic type U (universal controller).

Using the operator unit RMZ790 or RMZ791, the controller permits:

- Activation of a preprogrammed application.
- Modification of a preprogrammed application.
- Free configuration of applications.
- Optimization of the controller settings.

For operating actions of the functions, refer to the Basic Documentation CE1P3150en.

The universal controller consists of terminal base and controller insert. It has a plastic housing with the printed circuit boards, 2 terminal levels and accommodates the connecting elements (electrical and mechanical) for one extension module (refer to "Accessories").

It can be mounted on a top hat rail (EN 60715-TH35-7.5), or on a wall.

The controller is operated either with the plug-in type or detached operator unit (refer to "Accessories").

Operating, display and connecting elements

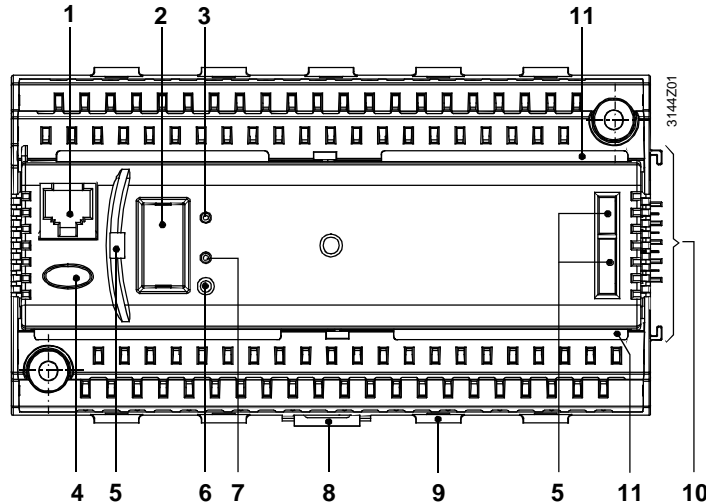

Key

- 1 Connection facility for the service tool (RJ45 connector)
- 2 Removable cover with connection facility for the operator unit.
- 3 LED (Run) for indicating the device's operating state: With the following meaning:
LED lit: Supply voltage, no fault in application and periphery
LED off: No supply voltage or application fault or periphery.
- 4 Button "!" with LED (red) to display fault status message and its acknowledgement.
 With the following meaning:
LED blinking: Fault status message, ready to acknowledge
LED lit: Fault status message still pending but not yet reset
LED off: No fault status message.
Press button: Acknowledge or reset fault.
- 5 Openings for plug-in type operator unit RMZ790.
- 6 Programming button "Prog": Learning button to changeover between the normal mode and the addressing mode to assume the physical device address (requires tool to operate).
- 7 Programming LED "Prog" to display normal mode (LED off) or addressing mode (LED on).
- 8 Catch for fitting the controller to a top hat rail.
- 9 Fixing facility for a cable tie (cable strain relief)
- 10 Electrical and mechanical connection elements for extension module.
- 11 Rest for the terminal cover.

Engineering Notes



- AC 24 V voltage required to power the controller. It must meet requirements for SELV/PELV (safety extra low-voltage).
- The transformers used must be safety isolating transformers featuring double insulation to EN 60742 or EN 61558-2-6. Design of switch-on period: 100 %.
- Fuses, switches, wiring and earthing must be in compliance with local regulations
- Sensor wires should not be run parallel to mains carrying wires that power fans, actuators, pumps, etc.
- It is recommended to use the standard applications provided. Specific plant situations may require certain adaptations
- Total max. 4 extension modules per RMU7..B can be connected.
 Select from 1 RMZ785, 2 RMZ787 or 2 RMZ788.

Mounting and installation notes

- Controllers and extension modules are designed for:
 - Mounting in a standard cabinet as per DIN 43 880.
 - Wall mounting on an existing tophat rail (EN 50022-35x7.5).
 - Wall mounting using two fixing screws.
 - Flush panel mounting.
- Mounting in wet or humid room not permitted. Must have proper ambient conditions
- If the controller is not operated inside a control panel, use the detached operator unit RMZ791 in place of the plug-in type operator unit RMZ790.
- Disconnect the system from the power supply prior to mounting and installation the controller.
- **Do no remove controller from the terminal base!**
- If extension modules are used, they must be attached to the right side of the controller in the correct order in accordance with the internal configuration.
- Extension modules are not wired to one another or the controller. Electrical connections are automatic as of insertion. If it is not possible to arrange the extension modules side by side, the first of the detached modules must be connected to the last previous module or to the controller using the RMZ780 module connector. In that case, the cumulated cable length may not exceed 10 m.
- All connection terminals for protective extra low-voltage (sensors, data bus) are located in the upper half of the unit, those for mains voltage (actuators and pumps) at the bottom.
- Each terminal (spring cage terminal) can only accommodate one solid wire or one stranded wire. Cables must be stripped to 7 to 8 mm to connect. To introduce the cables into the spring cage terminals and to remove them, a screw driver size 0 or 1 required. Cable strain relief can be provided with the help of the fixing facility for cable ties.
- The controller mounted on a top hat rail together with modules can only be removed from the rail after the module directly attached to the controller has been removed
- The controller is supplied complete with installation instructions and operating instructions

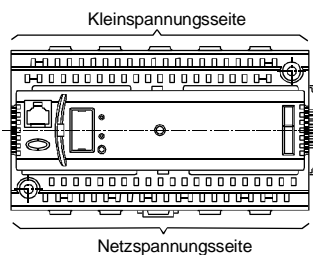

Commissioning notes

- Using the operator unit RMZ790 or RMZ791, or the service tool, staff trained by HVAC Products and having the required access rights can change the configuration and the parameters online or offline at any time.
- During commissioning, the application is switched off. The outputs are in a defined OFF state. No process and alarm signals are issued on the bus
- The controller restarts automatically after completing configuration
- When leaving the commissioning pages, the peripheral devices connected to the universal inputs (including the extension modules) are automatically tested and identified. An error message is generated if peripheral device is missing
- The operator unit can be removed and plugged in or connected while the controller is operating
- If adaptations to specific plants are required, they must be recorded and the documentation kept inside the control panel.
- For the procedure to be followed when starting up the plant for the first time, refer to the installation instructions.

General notes



Maintenance	The universal controller RMU7..B is maintenance free (no battery changes, no fuses). The housing may only be cleaned with a dry towel.
Repair	The universal controller cannot be repaired on site.
Disposal	The universal controller is subject to Directive 2002/96/EG (WEEE, Waste of Electrical and Electronic Equipment). <i>"The device is considered electronics device for disposal in terms of European Directive 2002/96/EG (WEEE) and may not be disposed of as domestic garbage. The corresponding national, legal regulations must be observed and the device must be disposable via the appropriate channels. Observe all local and applicable laws."</i>



Technical data

Power supply (G, G0)	Rated voltage	AC 24 V \pm 20 %
	Safety extra low-voltage (SELV) / protective extra low-voltage (PELV) to Requirements for external safety isolating transformer (100 % ED, maximum 320 VA) to	HD 384 EN 60742 / EN 61558-2-6
	Frequency	50/60 Hz
	Power consumption (excl. modules)	12 VA
	Supply line fusing	max. 10 A.
Functional data	Clock reserve	48 hours typical, min. 12 hours.
Universal inputs	Number	See "Type overview"
Measured value inputs (X...)	Sensors	
	Passive	LG-Ni 1000, T1, Pt 1000 2x LG-Ni 1000 (averaging)
	Active	0...1000 Ω , DC 0...10 V
Status inputs (X...)	Contact sensing	
	Voltage	DC 15 V
	Current	5 mA
	Requirements for status contacts	
	Signal coupling	potential-free
	Type of contact	maintained contact
	Insulating strength against mains potential	AC 3750 V to EN 60730
	Requirements for pulse contacts	Screened cables recommended
	Signal coupling	potential-free
	Type of contact	Pulse contact
Mechanical transmitter (reed contract)		
Maximum pulse frequency	25 Hz	
Minimum pulse length	20 ms (with max. 10 ms bounce length)	
Electronic transmitter		
Maximum pulse frequency		
Minimum pulse length	100 Hz	
Insulating strength against mains potential	5 ms AC 3750 V to EN 60730.	
Perm. resistance		
Contacts closed	max. 200 Ω	
Contacts open	min. 50 k Ω .	
Outputs	Number of positioning and switching outputs	refer to "Type summary"
Positioning outputs Y...	Output voltage	DC 0...10 V
	Output current	\pm 1 mA
	Max. load	continuous short-circuit
Switching outputs AC 230 V (Q1x...Q7x)	External supply line fusing	
	Non-renewable fuse (slow)	max. 10 A
	Automatic line cutout	max. 13 A
	Release characteristic	B, C, D to EN 60898

	Relay contacts	
	Switching voltage AC current	Max. AC 250 V min. AC 19 V
	At 250 V	max. 4 A res., 3 A ind. (cos φ = 0.6)
	At 19 V Switch-on current	min. 5 mA min. 20 mA max. 10 A (1 s).
	Contact life at AC 250 V	Guide value
	At 0.1 A res. At 0.5 A res. At 4 A res.	2 x 10 ⁷ cycles
		4 x 10 ⁶ cycles (N. O.)
	Red. factor at ind. (cos φ = 0.6).	2 x 10 ⁶ cycles (changeover)
		3 x 10 ⁵ cycles (N.O.)
		1 x 10 ⁵ cycles (changeover)
		0.85
	Insulating strength	
	between relay contacts and system electronics (reinforced insulation)	AC 3750 V, to EN 60730-1
	between neighboring relay contacts (operational insulation) Q1↔Q2; Q3↔Q4; Q6↔Q7	AC 1250 V, to EN 60730-1
	between relay groups (reinforced insulation) (Q1, Q2) ↔ (Q3, Q4) ↔ (Q6, Q7)	AC 3750 V, to EN 60730-1.
Power supply external devices (G1)	Voltage	AC 24 V
	Power	max. 4 A.
Interfaces	KNX bus	
	Type of interface	KNX-TP1
	Bus loading number	2,5
	Bus power supply (decentral., can be switched off)	25 mA
	Power failure of short duration to EN 61000-4-11	100 ms with 1 extension module.
	Extension bus	
	Connector specification	4 contacts SELV/PELV
	Number of plug-in cycles	max. 10
	Service tool connection facility	RJ45 connector
Permissible line length	For passive measuring and positioning signals	(measuring errors can be corrected on the "Settings / Inputs" menu)
	Type of signal	max. 300 m
	LG-Ni 1000, T1	max. 300 m
	Pt 1000	max. 300 m
	0...1000 Ω	max. 300 m
	Contact sensing (status and impulse contacts).	max. 300 m.
	For DC 0...10 V measuring and control signals	refer to Data Sheet for the signal delivering device.
	For KNX bus	max. 700 m
	Type of cable	2-core without screening, twisted pairs.
	For switching outputs (Q1x...Q7x)	max. 300 m.
Electrical connections	Connection terminals	Spring cage terminals
	For wires	\varnothing 0,6 mm ... 2.5 mm ²
	For stranded wires without ferrules	0.25 ... 2.5 mm ²
	For stranded wires with ferrules	0.25 ... 1.5 mm ²
	KNX bus connection	Non-interchangeable.
Degree of protection	Degree of protection of housing to IEC 60529	IP 20 (when mounted).
	Safety class to EN 60730	Device suited for use with equipment of safety class II.
Ambient conditions	Operation to	IEC 60721-3-3
	Climatic conditions	Class 3K5
	Temperature (housing and electronics)	0...50 °C
	Humidity	5...95 % r. h. (non-condensing)
	Mechanical conditions	Class 3M2.
	Transport to	IEC 60721-3-2
	Climatic conditions	Class 2K3
	Temperature	-25...+70 °C
	Humidity	<95 % r. h.
	Mechanical conditions	Class 2M2.
Classifications to EN 60730	Mode of operation, automatic controls	Type 1B.
	Degree of contamination, controls' environment	2
	Software class	A
	Rated surge voltage	4000 V
	Temperature for ball-pressure test of housing	125 °C

Materials and colors	Terminal base	Polycarbonate, RAL 7035 (light-grey) Packaging
	Controller insert	Polycarbonate, RAL 7035 (light-grey) Packaging
	Packaging	Corrugated cardboard
Standards, guidelines	Product safety	
	Automatic electrical controls for household and similar use	
	Applications	EN 60730-1
	Special requirements for energy controllers	EN 60730-2-11
	Electrical safety	EN 50491-3
	Electromagnetic compatibility	
	For use in industrial and residential environment	
Immunity	EN 60730-1, EN 50491-5-3	
Emissions	EN 60730-1, EN 50491-5-2	
 Conformity to		
EMC directive	2004/108/EC	
Low voltage directive	2006/95/EC.	
 Conformity		
Australian EMC Framework	AS/NZS 61000-6-3	
Radio Interference Emission Standard		
Environmental compatibility	ISO 14001 (Environment)	
The product environmental declaration CE1E3110en01	ISO 9001 (Quality)	
contains data on environmentally compatible product design	SN 36350 (Environmentally	
and assessments (RoHS compliance, materials composition,	compatible products)	
packaging, environmental benefit, disposal)	2002/95/EG (RoHS)	
Dimensions (weight)	Excl. packaging	0.49 kg

Connection diagrams

Connection diagrams

RMU710B

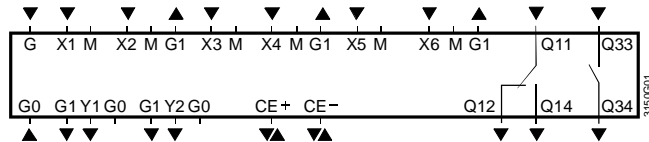

RMU720B

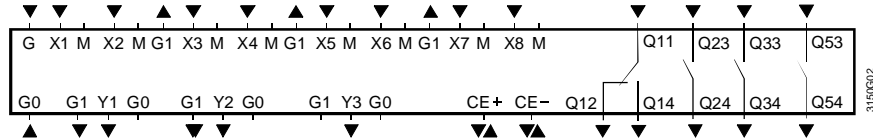

RMU730B

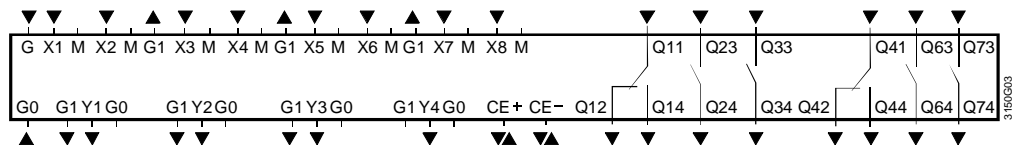

Key

G, G0	Rated voltage AC 24 V.
G1	AC 24 V output voltage to supply external active sensors, detectors, monitors or transmitters.
M	Measuring neutral for signal input.
G0	System ground for signal output.
X1...X8	Universal signal inputs for LG-Ni 1000, 2x LG-Ni 1000 (averaging), T1, Pt 1000, DC 0...10 V, 0...1000 Ω (setpoint), 1000...1175 Ω (rel. setpoint), pulse, contact sensing (potential-free)
Y1...Y4	Control or status outputs, analog DC 0...10 V.
Q2x/3x/5x/6x/7x	Potential-free relay outputs (N.O. contact) for AC 24...230 V
Q1x/4x	Potential-free relay outputs (changeover) for AC 24...230 V
CE+	KNX bus data line, positive.
CE-	KNX bus data line, negative.

Notes

Each terminal (spring cage terminal) can only accommodate one solid wire or one stranded wire. Double terminals are internally interconnected.

Connection diagrams

Connections on the measuring side

Examples:

Connection diagram 1: Measuring section with passive main and auxiliary sensors and passive signal source

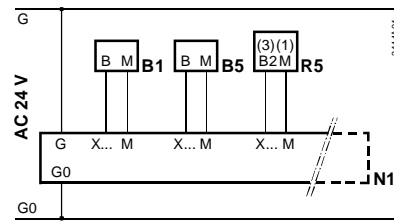

Connection diagram 2: Measuring section with active sensor and active signal source

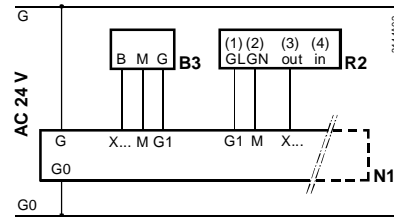

Connection diagrams 3 and 4: Measuring section with CO₂/VOC- and CO₂ evaluation.

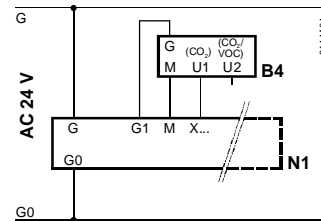
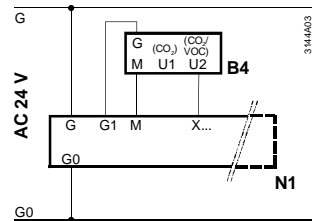

Connections on the control and monitoring side

Connection diagram 5: Measuring section with pulse transmitter

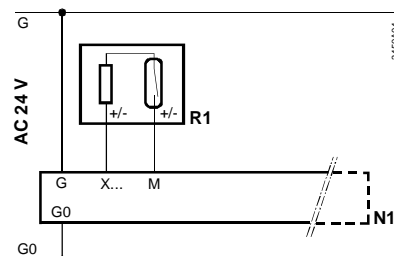

Recommendation:
Use shielded wires

Connection diagram 6:

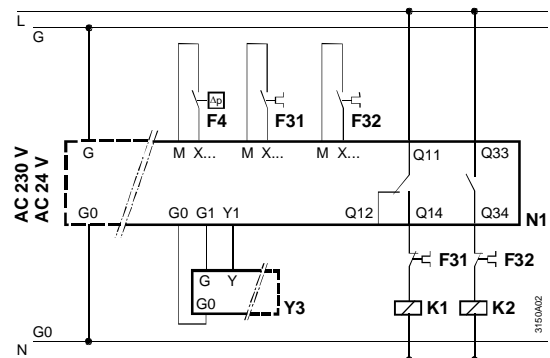

Legend to the connection diagrams 1 through 6

- | | | | |
|----|--|--------|---------------------------------------|
| N1 | Universal controller RMU7..B | F3 | Overcurrent trigger contact |
| B1 | Supply air temperature sensor QAM2120... | F4 | Differential pressure sensor QBM81... |
| B3 | Frost sensor QAF63.2/QAF63... | K1, K2 | Motor protection for fan |
| B4 | CO ₂ sensor QPA2000 | R1 | Reed pulse transmitter |
| B4 | CO ₂ /VOC sensor QPA2002/QPA2002D | R2 | Setpoint adjuster BSG61 |
| B5 | Room temperature sensor QAA24 | R5 | Setpoint shifting unit BSG21.5 |
| | | Y3 | Actuating device for heating |

Overview of the preprogrammed standard applications

Controller type	Plant type	Application number/description	Anlagenschema
RMU710B	A01	<p>ADA001 U1B HQ</p> <p>Supply air temperature control with hot water air heating coil.</p> <p><i>Variant:</i></p> <p>Room (extract)/supply air temperature cascade control with minimum and maximum limitation of the supply air temperature.</p>	
	A02	<p>ADB001 U1B HQ</p> <p>Supply air temperature control with chilled water air cooling coil.</p> <p><i>Variant:</i></p> <p>Room (extract)/supply air temperature cascade control with minimum and maximum limitation of the supply air temperature.</p>	
	A03	<p>ADC001 U1B HQ</p> <p>Supply air temperature control with hot water heating coil and cold water cooling coil.</p> <p><i>Variant:</i></p> <p>Room (extract)/supply air temperature cascade control with minimum and maximum limitation of the supply air temperature.</p>	
	A04	<p>AEA001 U1B HQ</p> <p>Supply air temperature control with mixing air dampers and hot water heating coil in sequence.</p> <p><i>Variante:</i></p> <p>Room (extract)/supply air temperature cascade control with minimum and maximum limitation of the supply air temperature.</p>	
	A05	<p>ADAE01 U1B HQ</p> <p>Supply air temperature control with plate heat recovery system and hot water air heating coil in sequence.</p> <p><i>Variant:</i></p> <p>Room (extract)/supply air temperature cascade control with minimum and maximum limitation of the supply air temperature.</p>	

Controller type	Plant type	Application number/description	Anlagenschema
RMU720B	A01	<p>AEC001 U2B HQ</p> <p>Supply air temperature control with mixing air dampers and cold water cooling coil in sequence.</p> <p><i>Variant:</i></p> <p>Room (extract)/supply air temperature cascade control with minimum and maximum limitation of the supply air temperature.</p>	
	A02	<p>ADCE01 U2B HQ</p> <p>Supply air temperature control with plate-type heat recovering, hot water heating coil and cold water cooling coil in sequence.</p> <p><i>Variant:</i></p> <p>Room (extract)/supply air temperature cascade control with minimum and maximum limitation of the supply air temperature.</p>	
	A03	<p>ADFB01 U2B HQ</p> <p>Supply air temperature control with hot water heating coil and cold water cooling coil.</p> <p>Room humidity control with steam humidifier.</p> <p><i>Variant:</i></p> <p>Room (extract)/supply air temperature cascade control with minimum and maximum limitation of the supply air temperature.</p>	
	A04	<p>AEDB01 U2B HQ</p> <p>Supply air temperature control with mixing air dampers and hot water heating coil in sequence.</p> <p>Room humidity control with steam humidifier.</p> <p><i>Variant:</i></p> <p>Room (extract)/supply air temperature cascade control with minimum and maximum limitation of the supply air temperature.</p>	
	A05	<p>ADDP01 U2B HQ</p> <p>Supply air temperature control with thermal wheel heat recovery system and hot water air heating coil in sequence.</p> <p>Room humidity control with steam humidifier.</p> <p><i>Variant:</i></p> <p>Room (extract)/supply air temperature cascade control with minimum and maximum limitation of the supply air temperature.</p>	

Controller type	Plant type	Application number/description	Anlagenschema
RMU730B	A01	<p>AEFB01 U3B HQ</p> <p>Supply air temperature control with mixing air dampers and cold water cooling coil in sequence.</p> <p>Room humidity control with steam humidifier.</p> <p><i>Variant:</i></p> <p>Room (extract)/supply air temperature cascade control with minimum and maximum limitation of the supply air temperature.</p>	
	A02	<p>ADFP01 U3B HQ</p> <p>Supply air temperature control with rotating heat recovery device, hot water heating coil and cold water cooling coil in sequence.</p> <p>Room humidity control with steam humidifier.</p> <p><i>Variant:</i></p> <p>Room (extract)/supply air temperature cascade control with minimum and maximum limitation of the supply air temperature.</p>	
	A03	<p>ADZA01 U3B HQ</p> <p>Room (extract air)/supply air temperature cascade control with minimum and maximum limitation of the supply air temperature, with hot water air reheater and chilled water air cooling coil in sequence.</p> <p>Room humidity control with spray humidifier (release).</p> <p>Dewpoint temperature control (supply air humidity constant) with hot water air preheating and cold water air cooler in sequence.</p>	
	A04	<p>AEZH01 U3B HQ</p> <p>Room (extract air)/supply air temperature cascade control with minimum and maximum limitation of the supply air temperature, with hot water air reheater and chilled water air cooling coil in sequence.</p> <p>Room humidity control with spray humidifier (release).</p> <p>Dewpoint temperature control (constant supply air humidity) with mixed air dampers, hot water air preheater and chilled water air cooling coil in sequence.</p>	
	A05	<p>AEZH02 U3B HQ</p> <p>Room (extract air)/supply air temperature cascade control with minimum and maximum limitation of the supply air temperature, with mixed air dampers, hot water air reheater and chilled water air cooling coil in sequence.</p> <p>Room humidity control with spray humidifier (release) and cold water air cooling.</p> <p>Dewpoint temperature control (constant supply air humidity) with hot water air preheater.</p>	

Dimensions

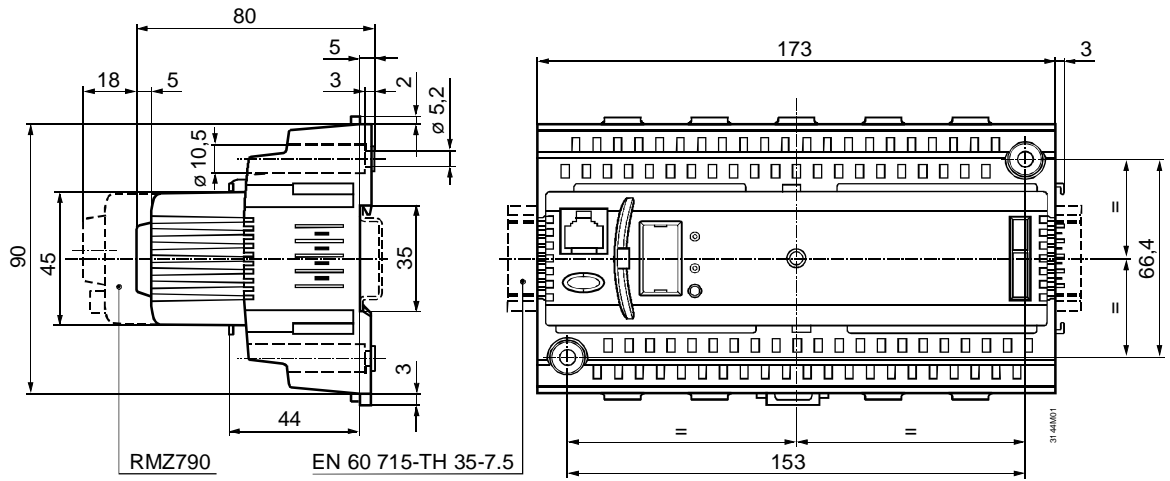

Masse in mm