

ROTARY MOTORIZED VALVES
MIXING VALVE
SERIES 3F



Flange

3F, DN 20-150, cast iron, PN 6. Flange.

OPERATION

The ESBE series F is a valve made of cast iron for use in heating and cooling installations.

The mixing proportions are adjusted manually with a handle or, in automatically controlled systems, by means of an actuator. Suitable actuators are ESBE series ARA600 for DN ≤40 or series 90. The valve can also be equipped with ESBE controllers series 90C, CRA120 or CRA110 and CRB ≤DN40.

Valve series 3F is available in dimensions DN 20-150 with flanged connections.

The scale is graded on both sides and can be turned, allowing a choice of mounting positions. Operation angle = 90°.

SERVICE AND MAINTENANCE

All major parts are replaceable. The shaft seal consist two o-rings, one of which can be replaced without the need for draining down the system or dismantling the valve. However, before doing so, the system must be depressurized.

INSTALLATION EXAMPLES

All the examples of installations can be reversed. The valve position plate is graded on both sides and should at the installation be fitted in the correct position as shown in the instruction for installation.

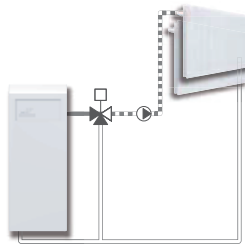

Mixing

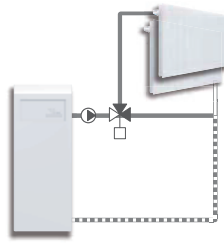

Diverting

VALVE 3F DESIGNED FOR

- Heating
- Comfort cooling
- Potable water
- Floor heating
- Solar heating
- Ventilation
- Zone
- District hot water
- District heating
- District cooling

SUITABLE ACTUATORS

The valve series 3F may most easily be fitted with ESBE actuators:

- Series ARA600 ≤DN40
- Series 90
- Series 90C
- Series CRB100 ≤DN40
- Series CRA110 ≤DN40
- Series CRA120

TECHNICAL DATA

Pressure class: _____ PN 6
 Media temperature: _____ max. 110°C, min. -10°C
 Differential pressure drop: DN 20-50, _____ max. 50 kPa
 DN 65-150, _____ max. 30 kPa
 Leakrate in % of flow: _____ max. 1.5%
 Rangeability Kv/Kv^{min}: _____ 100
 Connection: _____ Flange according to EN 1092-2

Material _____ DN 20-25 _____ DN 32-150
 Valve body: _____ Cast iron EN-JL 1030
 Slide: _____ brass CW 614N _____ brass CW 614N and stainless steel
 Bushing: _____ plastic _____ brass CW 602N
 Cover plate: _____ zinc _____ cast iron
 O-rings: _____ EPDM

REQUIRED ACTUATOR TORQUE

The figures below are intended only as a recommendation for ordinary installations. In some applications the valve may require even more actuator torque.

Valve size up to _____ DN 25 _____ actuator torque 3 Nm
 _____ DN 50 _____ 5 Nm
 _____ DN 80 _____ 10 Nm
 _____ DN 150 _____ 15 Nm

VALVE CHARACTERISTICS

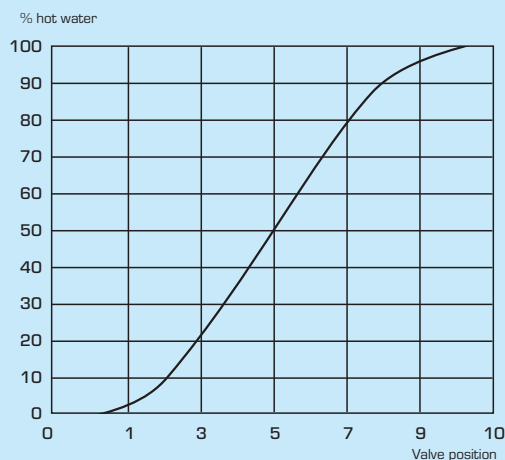

ROTARY MOTORIZED VALVES
MIXING VALVE
SERIES 3F

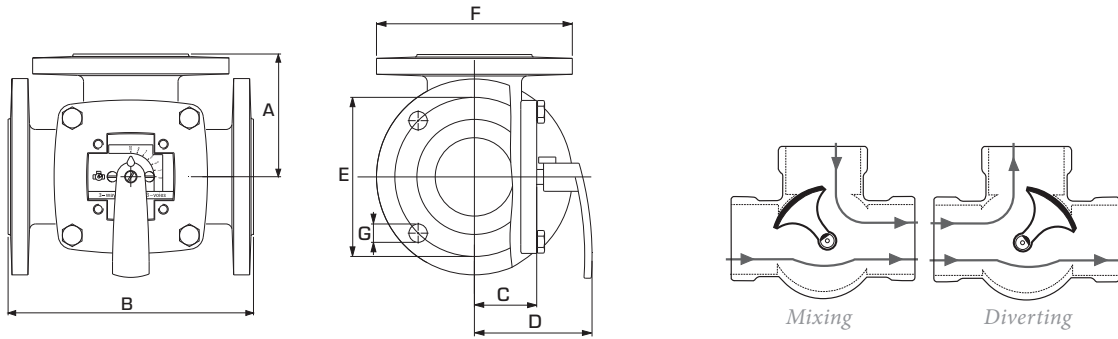

Flanged connection PN6,
 standard EN 1092-2

The flat-sided spindle top
 (as well as the indicator of the knob)
 points towards the sleeve position.

ROTARY MOTORIZED VALVES



SERIES 3F

Art. No.	Reference	DN	Kvs*	A	B	C	D	E	F	G	Weight [kg]
1110 01 00	3F 20	20	12	70	140	40	82	65	90	4x11.5	3.5
1110 02 00	3F 25	25	18	75	150	40	82	75	100	4x11.5	4.0
1110 03 00	3F 32	32	28	80	160	40	82	90	120	4x15	5.9
1110 04 00	3F 40	40	44	88	175	40	82	100	130	4x15	6.8
1110 06 00	3F 50	50	60	98	195	50	92	110	140	4x15	9.1
1110 08 00	3F 65	65	90	100	200	52	95	130	160	4x15	10.0
1110 10 00	3F 80	80	150	120	240	63	106	150	190	4x18	16.2
1110 12 00	3F 100	100	225	132	265	73	116	170	210	4x18	21.0
1110 14 00	3F 125	125	280	150	300	80	123	200	240	8x18	27.0
1110 16 00	3F 150	150	400	175	350	88	130	225	265	8x18	37.0

* Kvs-value in m³/h at a pressure drop of 1 bar. See flow chart on page 32.

ROTARY MOTORIZED VALVES
MIXING VALVE
SERIES 4F



Flange

4F, DN 32-150, cast iron, PN 6. Flange.

OPERATION

The ESBE series F is a valve made of cast iron for use in heating and cooling installations.

The mixing proportions are adjusted manually with a handle or, in automatically controlled systems, by means of an actuator. Suitable actuators are ESBE series ARA600 for DN ≤40 or series 90. The valve can also be equipped with ESBE controllers series 90C, CRA120 or CRA110 and CRB ≤DN40.

Valve series 4F is available in dimensions DN 32-150 with flanged connections.

The scale is graded on both sides and can be turned, allowing a choice of mounting positions. Operation angle = 90°.

SERVICE AND MAINTENANCE

All major parts are replaceable. The shaft seal consist two o-rings, one of which can be replaced without the need for draining down the system or dismantling the valve. However, before doing so, the system must be depressurized.

INSTALLATION EXAMPLES

All the examples of installations can be reversed. The valve position plate is graded on both sides and should at the installation be fitted in the correct position as shown in the instruction for installation.

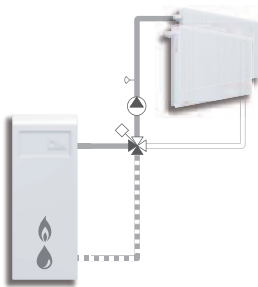

VALVE 4F DESIGNED FOR

- Heating
- Comfort cooling
- Potable water
- Floor heating
- Solar heating
- Ventilation
- Zone
- District hot water
- District heating
- District cooling

SUITABLE ACTUATORS

The valve series 4F may most easily be fitted with ESBE actuators:

- Series ARA600 ≤DN40
- Series 90
- Series CRB100 ≤DN40
- Series CRA110 ≤DN40
- Series CRA120

TECHNICAL DATA

Pressure class: _____ PN 6
 Media temperature: _____ max. 110°C, min. -10°C
 Differential pressure drop: DN 20-50, _____ max. 50 kPa
 DN 65-150, _____ max. 30 kPa
 Leakrate in % of flow: _____ max. 1.5%
 Rangeability Kv/Kv^{min}: _____ 100
 Connection: _____ Flange according to DIN 2531

Material _____ DN 20-25 _____ DN 32-150
 Valve body: _____ Cast iron EN-JL 1030
 Slide: _____ brass CW 614N _____ brass CW 614N and stainless steel
 Bushing: _____ plastic _____ brass CW 602N
 Cover plate: _____ zinc _____ cast iron
 O-rings: _____ EPDM

REQUIRED ACTUATOR TORQUE

The figures below are intended only as a recommendation for ordinary installations. In some applications the valve may require even more actuator torque.

Valve size up to _____ DN 25 _____ actuator torque 3 Nm
 _____ DN 50 _____ 5 Nm
 _____ DN 80 _____ 10 Nm
 _____ DN 150 _____ 15 Nm

VALVE CHARACTERISTICS

% hot water

Valve position

ROTARY MOTORIZED VALVES
MIXING VALVE
SERIES 4F

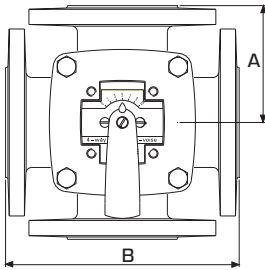

Flanged connection PN6,
 standard DIN 2531

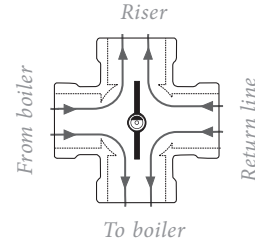
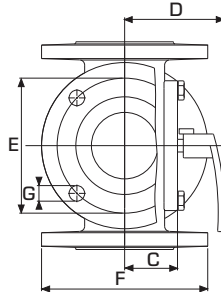

The flat-sided spindle top
 (as well as the indicator of the knob)
 points towards the sleeve position.

SERIES 4F

Art. No.	Reference	DN	Kvs*	A	B	C	D	E	F	G	Weight [kg]
1110 17 00	4F 32	32	28	80	160	40	82	90	120	4x15	7.0
1110 18 00	4F 40	40	44	88	175	40	82	100	130	4x15	8.2
1110 19 00	4F 50	50	60	98	195	50	92	110	140	4x15	11.0
1110 20 00	4F 65	65	90	100	200	50	92	130	160	4x15	12.2
1110 21 00	4F 80	80	150	120	240	65	108	150	190	4x18	20.0
1110 22 00	4F 100	100	225	132	265	81	124	170	210	4x18	25.0
1110 23 00	4F 125	125	280	150	300	81	124	200	240	8x18	35.0
1110 24 00	4F 150	150	400	175	350	89	131	225	265	8x18	45.0

* Kvs-value in m³/h at a pressure drop of 1 bar. See flow chart on page 32.